

iiNet BizPhone 'Conference' CPE860 Quick Startup Guide

CPE860 IP Conference Phone Quick Startup Guide



Packaging Contents

The following contents are included in your CPE860 package:

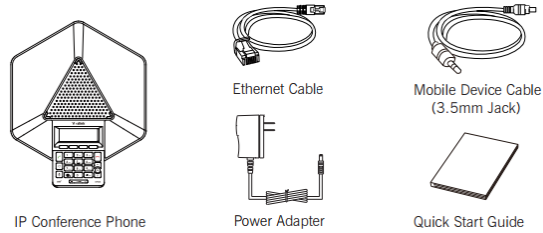

Note: The above packaging content is only applicable if you order a BizPhone Conference Plan. If you order a BizPhone Conference Plus Plan, it will also come with 2 x expansion microphones (CPE80).

Assembling the Phone

1. Connect the network and power, as shown below:
You have two options for network and power connections: AC Power option or PoE option.

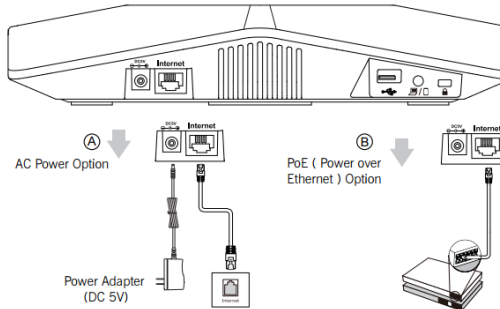

2. Connect the optional USB flash drive, as shown below:

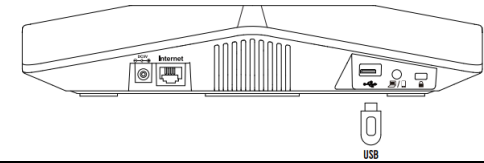

3. Connect the optional expansion microphone, as shown below:

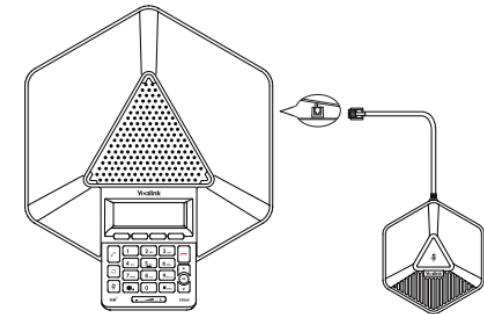

Note: Up to two expansion microphones can be connected to an IP conference phone.

4. Connect the optional PC or mobile device, as shown below:

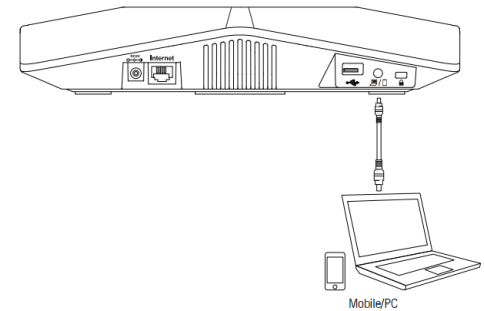

Startup the Phone

After the IP Phone is connected to the network and supplied with power, it automatically begins the initialisation process. After startup, the phone is ready to use (pre-configured).





HANDSET SETTINGS



Add a Contact

- Press the **Directory** soft key when the phone is idle, and then select the **All Contacts**.
- Press the **Add** soft key to add a contact.
- Enter a unique contact name in the **Name** field and contact numbers in the corresponding fields.
- Press the **Add** soft key to accept the change.



Delete a Contact

- Press the **Directory** soft key when the phone is idle, and then select **All Contacts**.
- Press  or  to select the desired contact, press the **Option** soft key and then select **Delete**.
- Press the **Ok** soft key when the LCD screen prompts "Delete Selected Items?"

Edit a Contact

- Press the **Directory** soft key when the phone is idle, and then select **All Contacts**.
- Press  or  to select the desired contact, press the **Option** soft key and then select **Detail**.
- Edit the contact information.
- Press the **Save** soft key to accept the change.





Volume Adjustment

- Press  during a call to adjust the receiver volume of the speaker.
- Press  when the handset is idle to adjust the ringer volume.



BASIC CALL FEATURES

Placing Calls

Do one of the following:

- Press .
Enter the number, and then press , , or the **Send** soft key.
- Enter the number.
Press , , or the **Send** soft key.

Answering Calls

Press , , or the **Answer** soft key.



Ending Calls

Press  or the **End Call** soft key.



Call Hold

Press the **Hold** soft key during an active call.

Call Resume

- If there is only a call on hold, press the **Resume** soft key.
- If there are two calls on hold, press  or  to select the desired call, and then press the **Resume** soft key.

Call Mute and Un-Mute

- Press  to mute the microphone during a call.
- Press  again to un-mute the call.



Local Conference

CPE860 can host up to five-way conference call with other parties.





To create a three-way local conference:

- Press the **Conf** soft key during an active call. The call is placed on hold.
- Enter the number of the second party, and then press the **Send** soft key.
- Press the **Conf** soft key again when the second party answers.

To join more parties in an established conference call:

- Press the **Manage** soft key after the conference call is established.
- Press the **NewCall** soft key to place a new call.
- Enter the number of the new party, and then press , , or the **Send** soft key.
- Press the **Conf** soft key when the party answers:
- Repeat above steps to join more parties in the established conference call.

During the conference call, you can do the following:

- Press the **Hold** soft key to place the conference on hold.
- Press the **Split** soft key to split the conference call into individual calls on hold.
- Press the **Manage** soft key, and then press  or  to select the desired party:
 - o Press the **Far Mute** soft key to forbid the selected party from speaking. The muted party can hear everyone, but no one can hear the muted party.
 - o Press the **Remove** soft key to remove the selected party from the conference call.
- Press the **NewCall** soft key to place a new call.
- o Press the **Back** soft key to return to the previous screen.
- Press  to mute the conference call.
- Press  or the **EndCall** soft key to drop the conference call.

NOTE: For more information about other IP Conference Phone features, refer to the BizPhone CPE860 IP Conference Phone User Guide (contact your Administrator)